

VM25 SYSTEM

研磨線上/平衡/量測/防護/控制裝置

GRINDING LINE AUTOMATIC SOLUTION

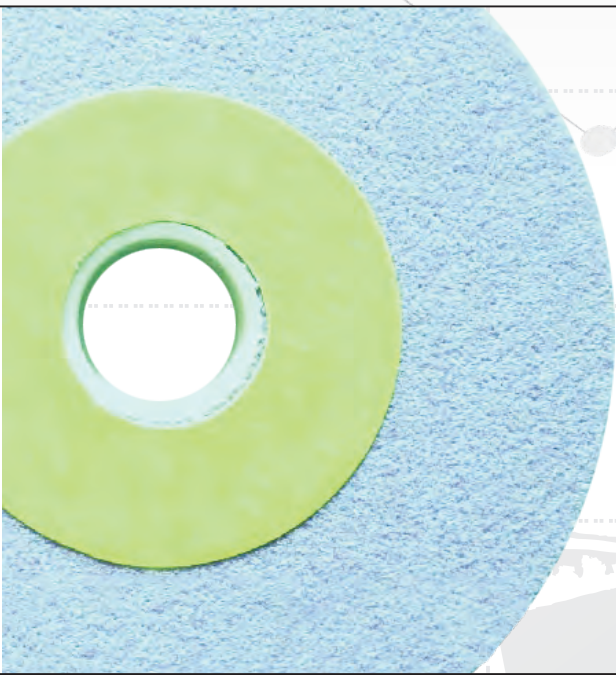

BALANCER

GAP ELIMINATOR

GAUGE

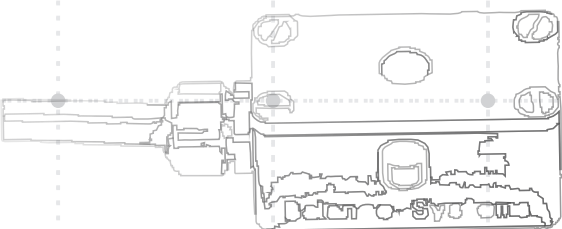

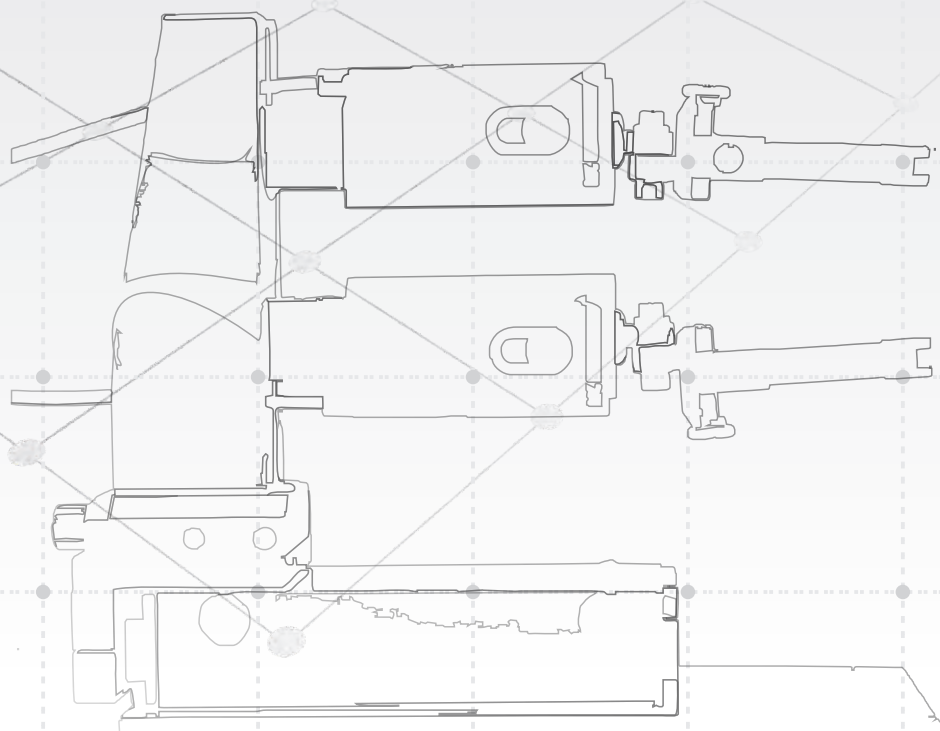

心得科技工業股份有限公司

USync | www.usync.com.tw

台北總公司地址：新北市新店區寶中路92號8樓

TEL：02-2917-4202

台中分公司地址：台中市西屯區工業一路2巷3號7樓之4

TEL：04-2359-8606

SYSTEM

多功能系統- 應用介紹

VM25 系統架構

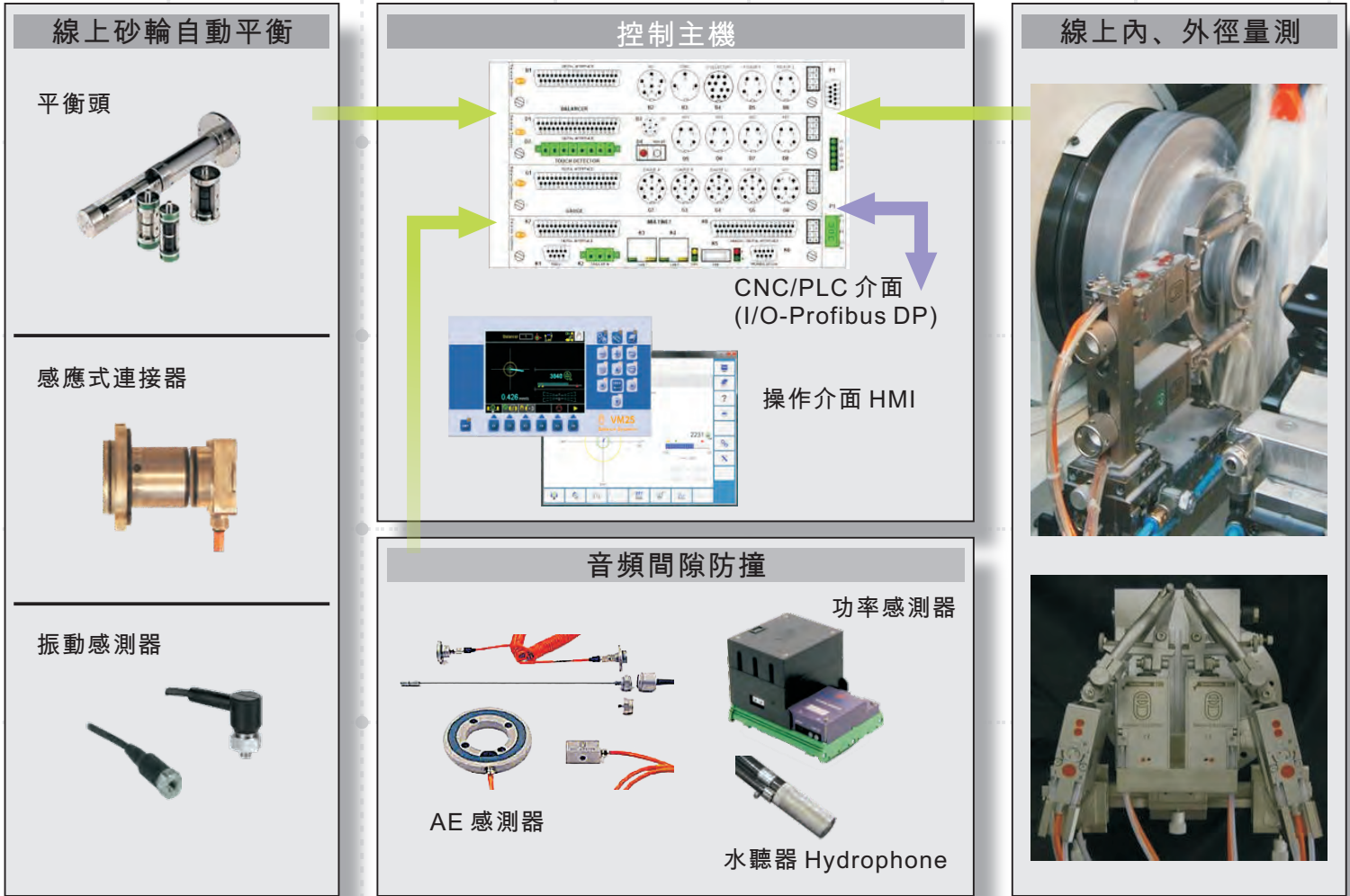

什麼能讓您提高磨削效率？

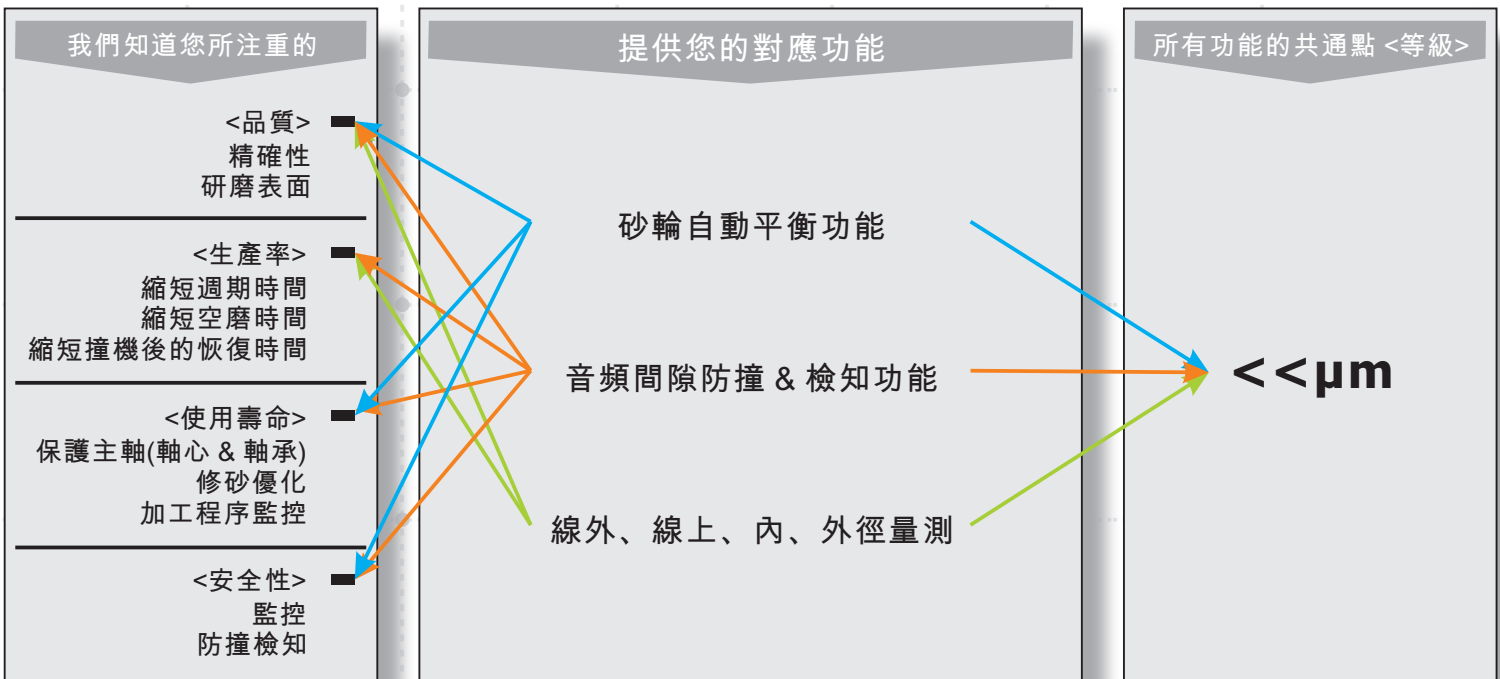

AUTO BALANCING

線上自動平衡

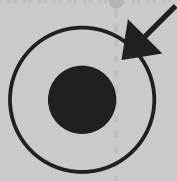
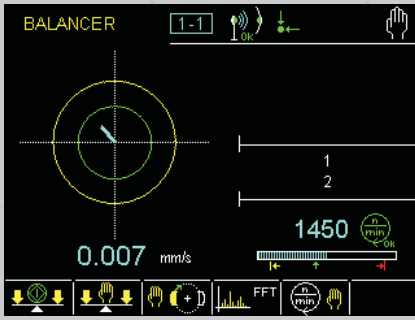

平衡頭專利結構設計，
避免砂輪側向晃動，研
磨表面振紋！

專利結構設計

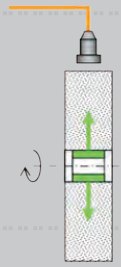
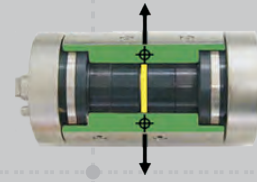

此設計更適合高轉速 (利於研磨)
且不造成表面波紋。

平衡系統特點

量測兩不同方向之振動值(i.e. X 與 Y)

1 平面不平衡校正，使用單一或兩頻道組合判斷信號(利用程式編輯自動選擇)

2 平面不平衡校正且使用兩平衡頭

高速 & 高平衡精度 (殘餘 < 5 m/s)

嵌入式 AE 感測器 間隙防撞檢知功能



1 plane



2 plane



附加功能

頻譜分析

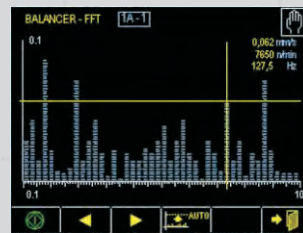

1 & 2 平面
之預平衡選配功能



IN-PROCESS GAUGING

線上內、外徑量測

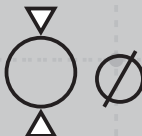
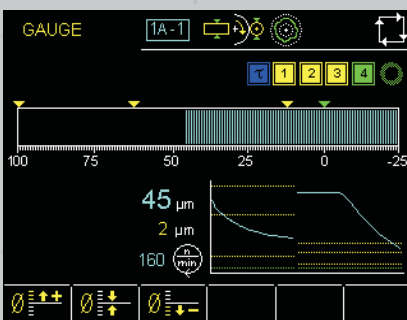

於研磨時同時監測工件
實際尺寸，確保工件達
到標準尺寸範圍！
量測單元精度解析
0.1 μ m！

成品容許尺寸判別

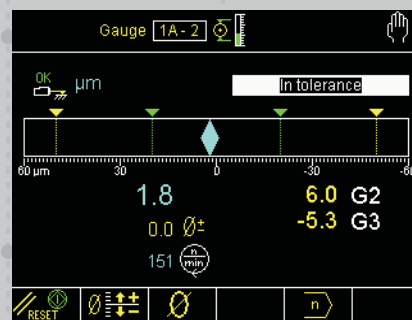

線外循環分析：
設定容許範圍
後，可在線外直
接判定產品尺寸
是否良好(Good
or No Good)

— | VM25 多功能系統架構 | —

BALANCER



GAP ELIMINATOR

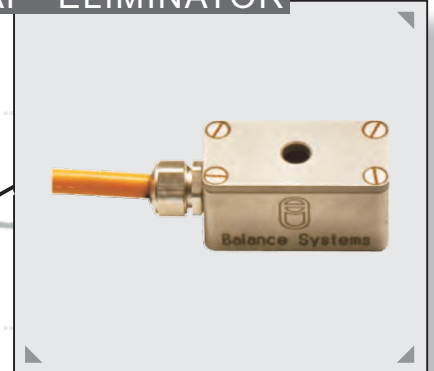

GAUGE

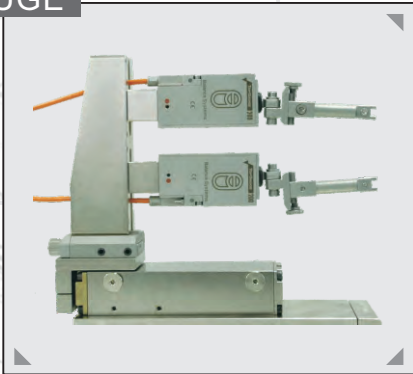

| 專利設計-防撞探指 |

撞擊



回復



歸零

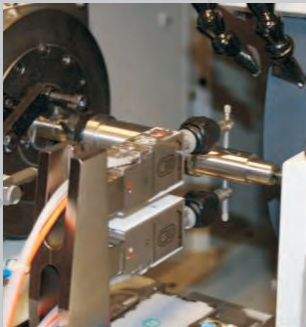

GO !!!



GAP & CRASH DETECTING

線上間隙探測與防撞檢知

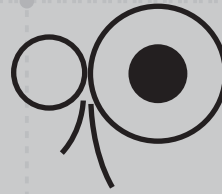
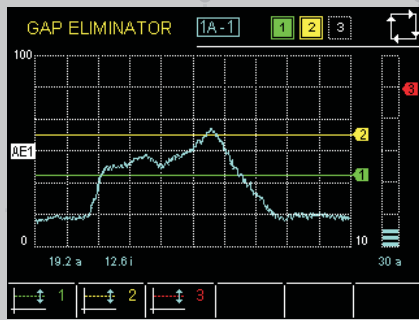

節省空跑時間，撞擊快速反應檢知，
大幅降低主軸損壞成本！
感測器反應時間最快 0.001sec！

間隙防撞 (Gap and Crash) - 應用介紹 -

< FFT Function 過濾雜訊 >

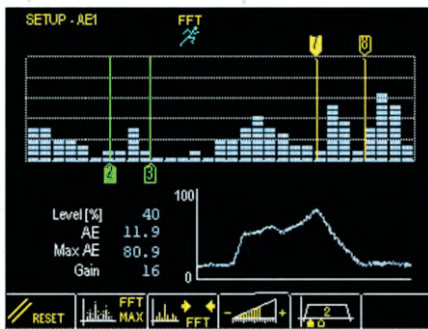

研磨接觸點偵測

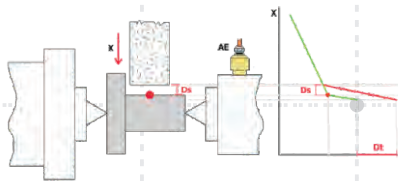

防撞檢知

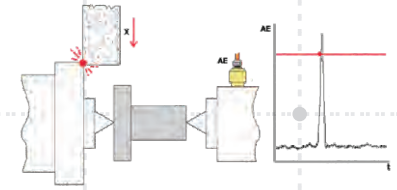

砂輪破裂檢知

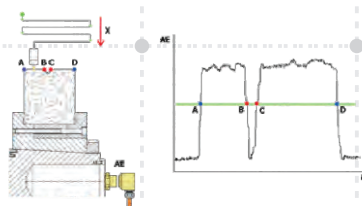

修砂完整性最佳化與形狀控制

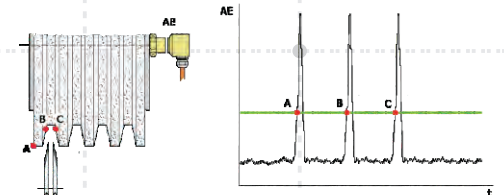

內螺紋對刀

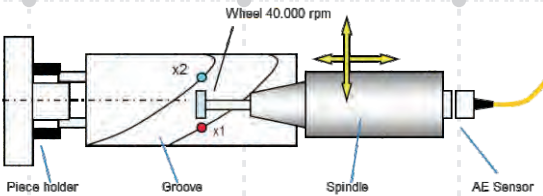

端點接觸功能應用

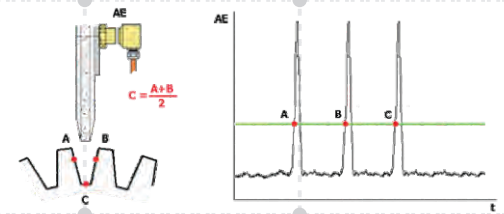

加工後量測-循圓分析功能

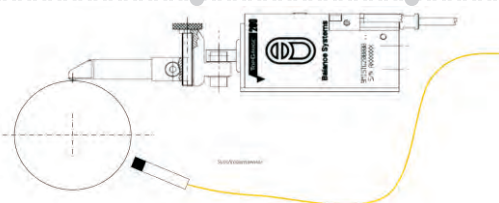
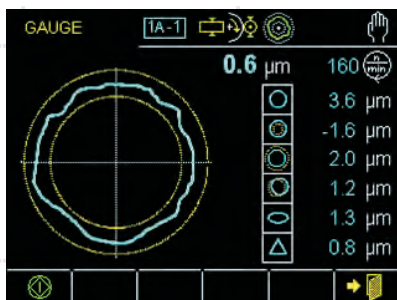

透過畫面顯示，可直接瞭解工件外型狀況，
利用循圓分析功能區分是否在真圓度設定範圍內，
檢查真圓度的偏移量。